

PF-90 / PF-80 FOLDER

OPERATOR GUIDE

Rev. 6/10

© 2009 Neopost USA Inc. All rights reserved.

Limitations of this Document

The information presented herein is subject to change. Neopost USA Inc. ASSUMES NO LIABILITY WHATSOEVER FOR ANY LOSSES OR DAMAGES RESULTING FROM USE OF THIS INFORMATION

TABLE OF CONTENTS





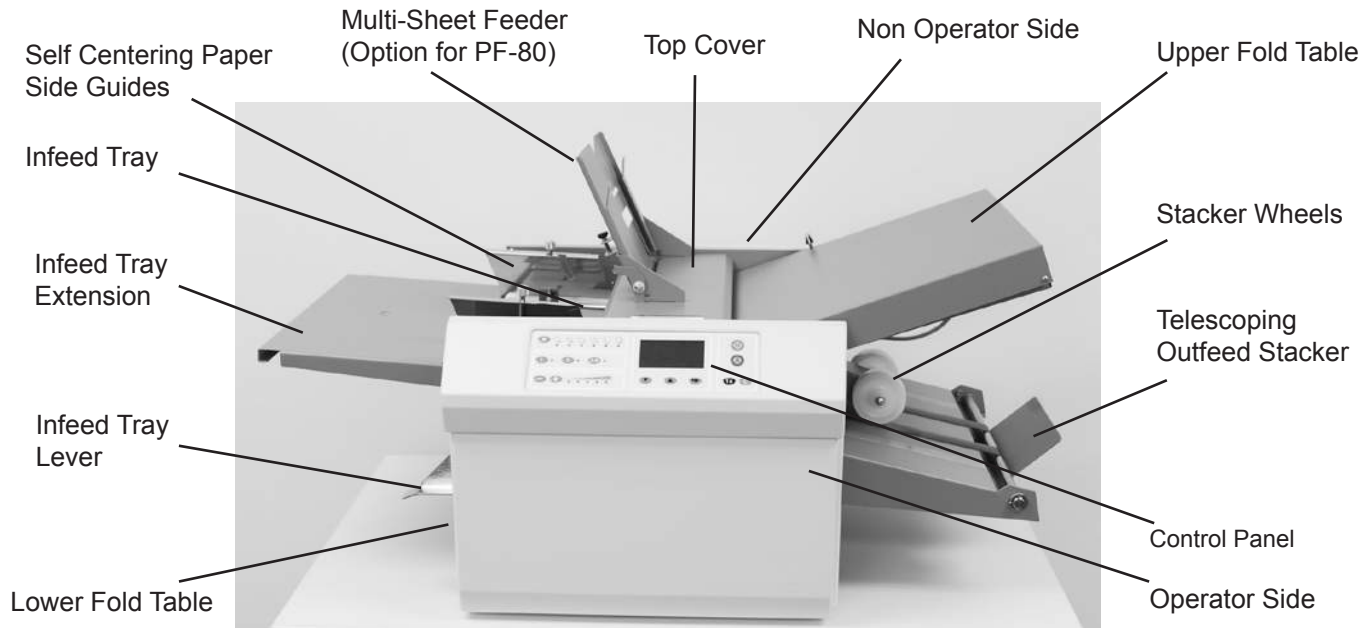

SUBJECT	PAGE
DESCRIPTION	1
SPECIFICATION	1
UNPACKING & SETUP	2
CONTROL PANEL	4
OPERATION	5
INTERFACE MENU	7
BATCH COUNTING	8
PF-80 CUSTOM FOLD SETUP	10
PF-90 CUSTOM FOLD SETUP	11
OPERATOR SETTINGS	14 - 17
Language	14
Standard Fold override	15
Stacker Override (PF-90 only)	16
Test Sheet Setting	17
Default Settings	17
MULTI-SHEET FEEDING	18
CROSS FOLDING	19
PF-80 STACKER WHEEL POSITIONING CHART	19
THICK PAPER / HIGH SPEED MODE	20
REMOVING INFEED TIRES	20
OPERATOR MAINTENANCE	21
TROUBLE SHOOTING	22

DESCRIPTION



The PF-90 / PF-80 Folder is designed to perform a wide variety of folds using a variety of paper weights. The fold tables are automatically adjusted for standard folds and custom folds. Documents that are 8 ½" x 11"/14" and 11" x 17" (A5, A4, A3, B4, B5 & B6) are detected by sensors on the in-feed tray. Batch counting, self-centering side guides, and the capability to cross-fold are added features. There are six pre-programmed standard folds and up to 35 custom folds available. The folder will automatically stop after the last document has been folded.

SPECIFICATIONS

Speed:	Standard Mode: Up to 16,450/hour, depending on fold type Thick Stock Mode: Up to 20,100/hour, depending on fold type
Hopper Capacity:	Up to 500 sheets of 20# paper (75gsm)
Paper size:	Min: 3.5" X 5" (88.9 W x 127 L mm) Max: 12.25" X 18" (311 W x 457 L mm)
Pre programmed fold types:	Letter  , Zig-Zag  , Single  , Gate  , Fold Out  Double Parallel 
Pre-Set Paper Sizes:	11", 14", 17", A5, A4, A3, B6, B5, B4
Languages:	English, Spanish, French, German, Italian & Dutch
Dimensions	Closed: 33" L x 20" W x 19" H (84 L x 51 W x 48 H cm) Fully Extended: 60" L x 20" W x 19" H (152 L x 51 W x 48 H cm)
Weight:	74 lbs (34 kg)
Power:	120V - 240V AC, 50/60 Hz, 2.5 amps.
Safety Certifications:	UL & CE Applied For

UNPACKING & SETUP

1. Check package for shipping damage. If there is shipping damage, do not discard the box.
2. Remove the machine and packed components from the box. The fold tables, telescoping stacker, Multi Sheet Feeder (standard feature PF-90, option for PF-80), power cord and cross-fold guide are wrapped separately in the box.

NOTE: Two people must lift the machine from the box.

3. Place the folder on a solid stand.

Install upper and lower fold tables, telescoping conveyor multi-sheet feeder and power cord

1. Be sure the tables are set firmly on the locating pins (Fig 1a & 1b). Slide each fold table in until it meets the first locating pin then push down to set in place.

Upper Fold Table Pins



Fig. 1a

Locating Pins

Lower Fold Table Pins

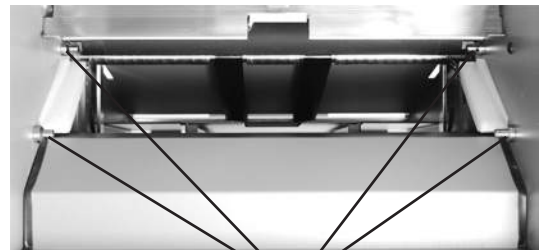

Fig. 1b

Locating Pins

2. Lock the fold table into position (PF-90 Only) (Fig. 2)
3. Repeat the same steps for the lower fold table.



Fig. 2

Fold Table Lock

4. Plug the fold table cables in to the receptacles on the side frame (Fig. 3a & 3b).

Upper Fold Table Receptacle Location



Fig. 3a

Plug in Receptacle

Lower Fold Table Receptacle Location



Fig. 3b

Plug in Receptacle

5. Insert the telescoping extension tray into the end of the outfeed conveyor (Fig. 4).

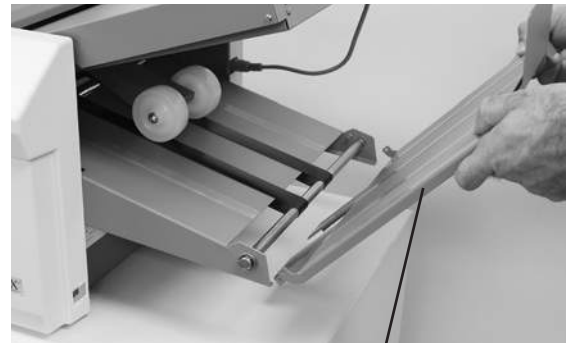

Fig. 4

Telescoping extension tray

6. Insert the Multi-Sheet Feeder into the four slots located on the top cover (Fig 5).

7. Make sure the power switch is in the "OFF" position. Plug the power cord into the power inlet and the wall outlet.



Fig. 5

4 Slots

CONTROL PANEL

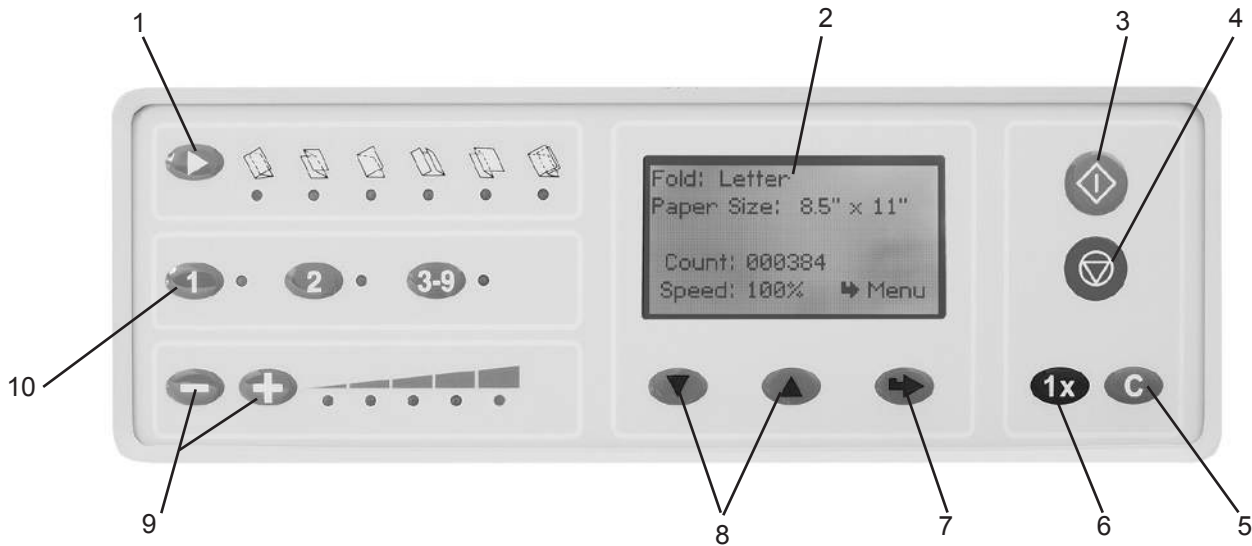

No.	NAME	FUNCTION
1	Standard Fold Button	Select the desired pre-programmed fold.
2	LED Interface	Displays current settings and used for setup and programming.
3	Start Button	Press to start the folder.
4	Stop Button	Press to stop the folder.
5	Clear/Reset Button	Clears operation and returns to main screen. NOTE: this button can be pressed at any time to return to the main screen. Resets the counter and clears fault indications.
6	Test Button "1x"	Test fold documents.
7	Enter Arrow	Used to save settings or advance to the next screen.
8	Up and Down Arrows	Used to scroll up and down through settings or change settings.
9	Speed Control Buttons	Increase or decrease speed
10	Custom Fold Buttons	Select and program a custom fold (see page 5).

OPERATION

1. Place power switch in the ON / "O" position.
2. Extend the catch tray as required.
3. PF-80 ONLY: Move the stacker wheels to the proper position for the paper size (Fig. 6) (Refer to chart on page 8). *Stacker wheels will automatically adjust on the PF-90.*

Stacker Wheel Positions A, B & C



Fig. 6

Stacker Wheels

4. Set the self-centring paper side guides for the width of the paper and lock in position using thumbscrews.

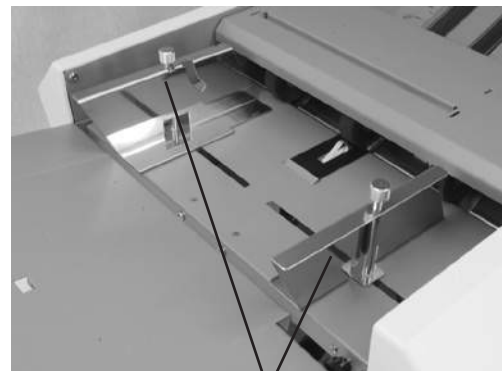

Fig.7

Self centering side guides

5. Adjust in-feed tray tension lever (Fig 7) for different paper weights. Move the lever up towards the "-" symbol for lighter paper and down toward the "+" symbol for heavier paper. The middle position is for standard paper weights.



Fig.7

Tension Lever

6. Raise the in-feed tray lever to lower the in-feed tray.
7. Neatly stack paper on the in-feed tray.
8. Lower the in-feed tray lever to raise the in-feed tray.

9. Select the type of fold desired by pressing the fold selection button (Fig 8).



Fig. 8 Fold selection button

10. Press the "1x" button on the control panel to test and check the folds (Fig 9).

NOTE: When the "1x" or "⏏" button is pressed, the fold tables return to the "home" position then reposition to the programmed setting.

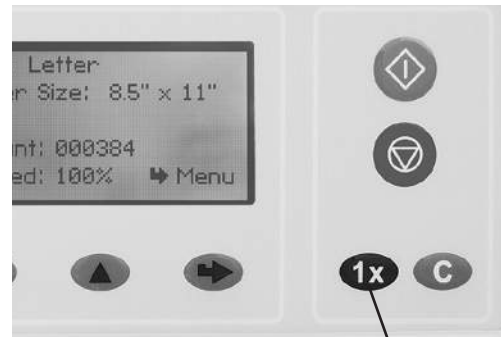

Fig. 9 Test Button

11. If the fold is skewed, remove paper, lower the infeed tray extension and turn the skew adjustment knob left or right to make corrections (Fig 10).



Fig. 10 Skew Adjuster

12. When satisfied with the test folds, press the "⏏" button to start the folder. Press the "⏏" button to stop.
13. Press the "-" or "+" buttons to adjust machine speed to desired level.

INTERFACE MENU

Fold: Letter
Paper Size: 8.5" x 11"

Count: 000000
Speed: 100% ↵ Menu

Main Screen - Press the "↵" button to advance to the Program Menu

Program Menu
Batch Counting ▼ ▲
Custom Folds Setup
Operator Settings
↵ enter

Press the "▼▲" buttons to scroll through the program settings. Press the "↵" button to enter the selection

Batch Counting
ManuBatch ▼ ▲
AutoBatch
↵ enter
C to exit

Choose between "ManuBatch" or "AutoBatch" - see pages 8 and 9

Custom Folds
Select Custom Fold ▼ ▲
1
↵ enter

Set up to 35 custom folds on the PF-90 or up to 25 custom folds on the PF-80 (page 10)

Operator Settings
Language
Standard Fold Override
Stacker Override
↵ select ▼

Operator Settings
Test Sheet Setting
Default Settings
↵ select ▲ back

Adjustable Operator Settings - see page 14

BATCH COUNTING

Two options are available for batch counting: ManuBatch for standard batch counting, and AutoBatch for programmed batch counting. Select “BatchCounting” and press the “↵” button to enter batch counting modes.

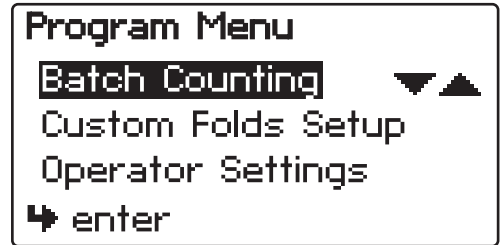

ManuBatch

The “ManuBatch” or “manual batch” feature allows you to program the number of sheets you would like to process in a set. When the set is complete, the folder will stop and automatically reset the batch count to the previously set number of sheets. It will then fold the next set when the “⬠” button is pressed.

1. To enter ManuBatch mode, highlight “ManuBatch” on the “Batch Counting” screen using the “▼▲” buttons. Press the “↵” button to enter.

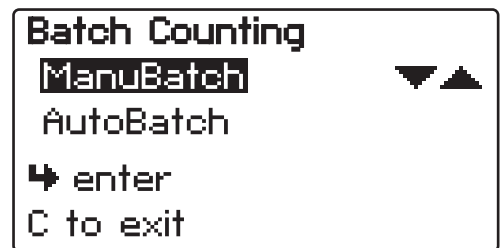

2. Select the number of sheets to be folded by pressing the “▼▲” buttons. Press the “⬠” button to start. Press the “C” button to exit to the main screen.

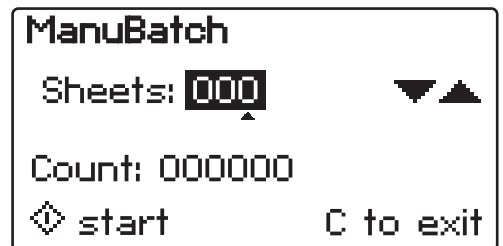

AutoBatch

“AutoBatch” or “automatic batch” allows you to batch count with automated features. In the Autobatch mode you can program the number of sheets you would like to process in a set, the total number of sets and the delay between each set. For example: you can program 10 sheets to be pulled to create a set, then program 100 sets to be processed with a 3-second time delay between each set.

1. To enter AutoBatch mode, highlight “AutoBatch” on the “Batch Counting” screen using the “▼▲” buttons. Press the “↵” button to enter.
2. “Sheets” is highlighted. Press the “▼▲” buttons to set the number of sheets for each set. Press the “↵” button to enter your selection and advance to the next screen.
3. “Sets” is highlighted. Press the “▼▲” buttons to select the number of sets. Press the “↵” button to enter your selection and advance to the next screen.
4. “Delay” is highlighted. Press the “▼▲” buttons to set the time delay between each set. Press the “↵” button to enter your selection and advance to the next screen.
5. Press the “◇” button to begin folding. The “▲” button can be pressed to edit the settings. Press the “C” button to exit to the main screen.

NOTE: If a fault occurs during a set the set will be completed when the fault is reset.

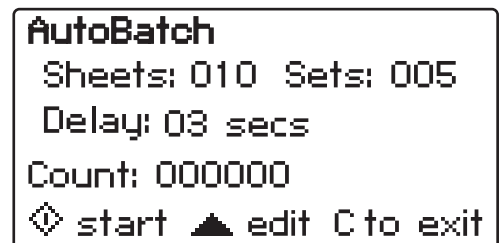
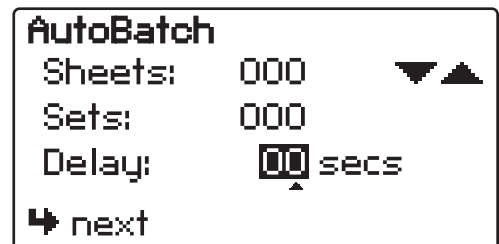
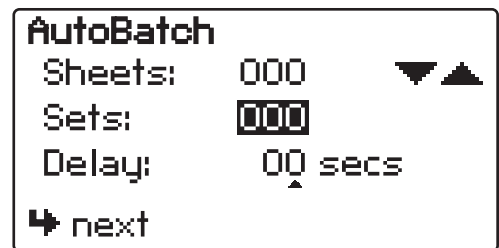
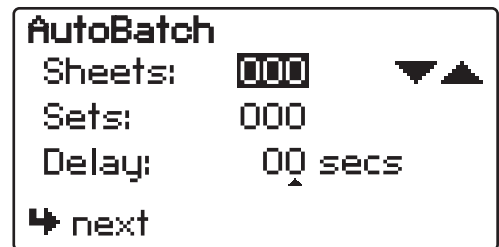
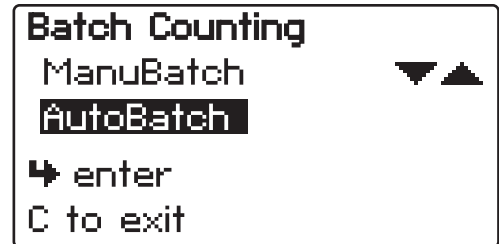

PF-80 CUSTOM FOLDS SETUP

The PF-80 has 25 custom fold settings that can be stored into memory for recurring jobs with fold settings that vary from the standard fold settings. To create or edit custom folds select "Custom Folds Setup" from the Program Menu screen and press the "↵" button to enter. See page 13 to help determine the new fold measurements.

1. Select the custom fold number you want to program using the "▼▲" buttons. Press the "↵" button to enter number and advance to the next screen.

2. The current settings for the custom fold will be displayed. Press the "↵" button to edit the settings or the "▲" to go back and select a different custom fold number.

Note: All custom folds are pre-set for a standard 11" C-fold.

3. Adjust Fold Table screen will be displayed. Use the "▼▲" buttons to change the upper fold table setting. Press the "↵" button to enter and advance to the lower fold table setting. Adjust the lower fold table and press the "↵" button to enter and advance to the test screen.

4. Press the "1x" button to ensure the proper folds have been entered. If the folds are correct press the "↵" button to save. If the folds need to be adjusted press the "▲" button to edit.

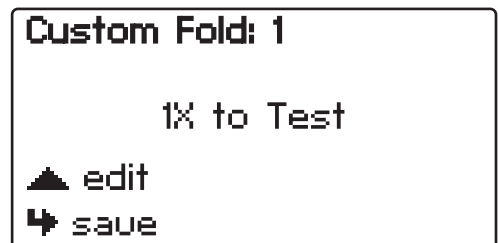
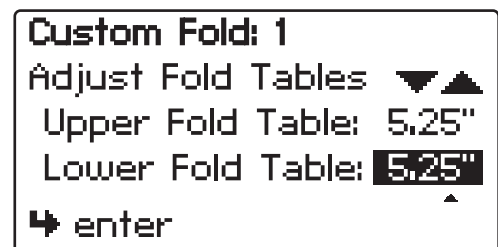
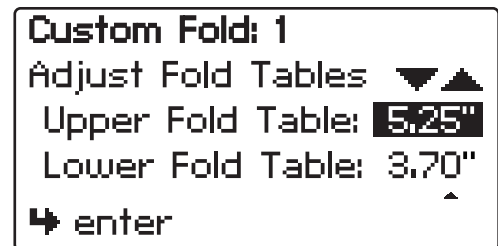
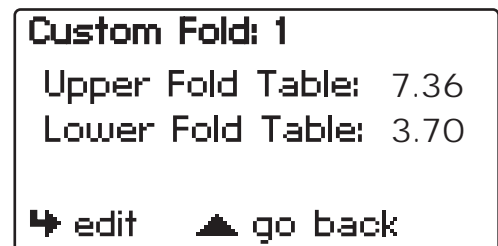
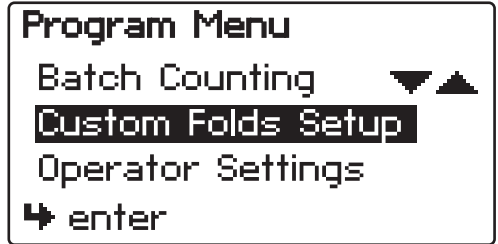

PF-90 CUSTOM FOLDS SETUP

The PF-90 has 35 custom fold settings that can be stored into memory for recurring jobs with fold settings that vary from the standard fold settings. To create or edit custom folds select "Custom Folds Setup" from the Program Menu screen and press the "↵" button to enter. See page 13 to help determine the new fold measurements.

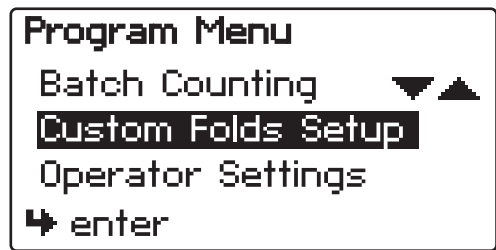

1. Select the custom fold number you want to program using the "▼▲" buttons. Press the "↵" button to enter number and advance to the next screen.

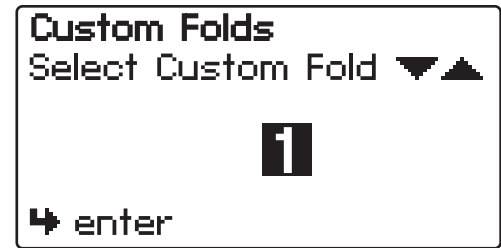

2. The current settings for the custom fold and stacker position will be displayed. Press the "↵" button to edit the settings or the "▲" to go back and select a different custom fold number.

Note: All custom folds are pre-set for a standard 11" C-fold.

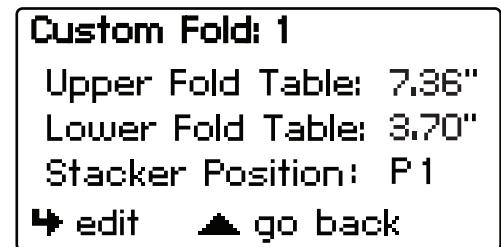

3. Adjust Fold Table screen will be displayed. Use the "▼▲" buttons to change the upper fold table setting. Press the "↵" button to enter and advance to the lower fold table setting. Adjust the lower fold table and press the "↵" button to enter and advance to Stacker Position screen.

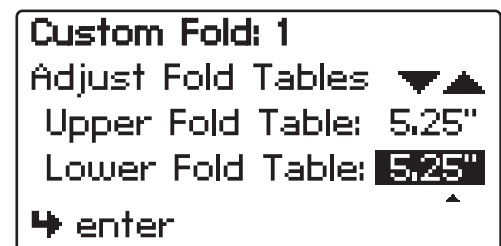
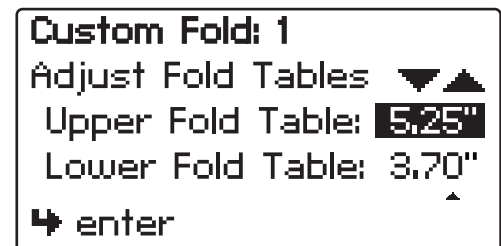

PF-90 CUSTOM FOLDS SETUP, cont.

5. There are 10 stacker positions available. Select the one that best matches the size of the folded document. Press “▼▲” buttons to select the correct position # P0 - P9. Press the “⏏” button to enter selection and advance to the test screen.

Stacker Wheel Positions:

P0	Folded size to: 3.75”
P1	Folded size to: 4.00”
P2	Folded size to: 4.43”
P3	Folded size to: 4.87”
P4	Folded size to: 5.30”
P5	Folded size to: 5.73”
P6	Folded size to: 6.16”
P7	Folded size to: 6.60”
P8	Folded size to: 7.03”
P9	Folded size to: 7.46” and greater

4. Press the “1x” button to ensure the proper fold and stacker positions have been entered. If the folds and stacker position are correct press the “⏏” button to save. If the folds or stacker wheels need to be adjusted press the “▲” button to edit.

```
Custom Fold: 1
Stacker Position ▼▲
Position: P0
Folded Size to: 3.75"
⏏ enter
```

```
Custom Fold: 1
Stacker Position ▼▲
Position: P1
Folded Size to: 4.00"
⏏ enter
```

```
Custom Fold: 1

1X to Test
▲ edit
⏏ save
```

Measuring Fold Lengths

Use the examples below to help determine the fold lengths for custom fold settings.

Example 1: “Z” Fold

1. Measure the length of panel “A”, enter this number as the upper fold table measurement.
2. Measure the length of panel “B”, enter this number as the lower fold table measurement.

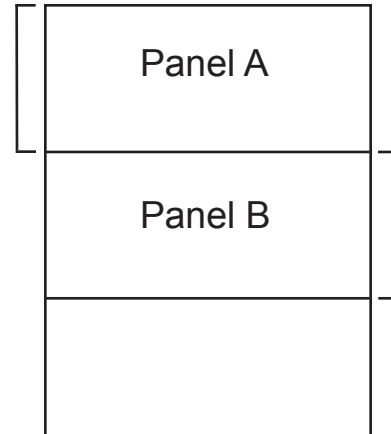

Example 2: “C” Fold

1. Measure the length of panel “A” + “B”, enter this number as the upper fold table measurement.
2. Measure the length of panel “B”, enter this number as the lower fold table measurement.

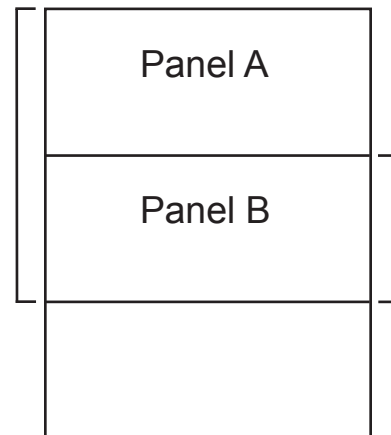

OPERATOR SETTINGS

A number of operator settings can be adjusted to personalize the PF-80 / PF-90. The settings include Language, Stacker Override, Standard Fold Override, and Test Sheet Setting. This section will review each setting and how to adjust them. If needed, there is a Default Settings option that will reset to factory settings. To advance to each setting press the “▼▲” buttons to highlight your selection and press the “↵” to select setting.

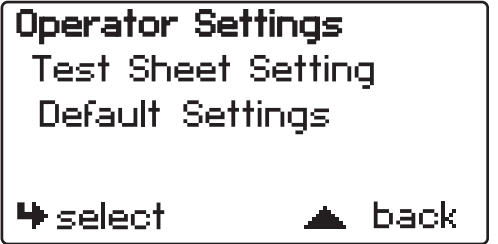
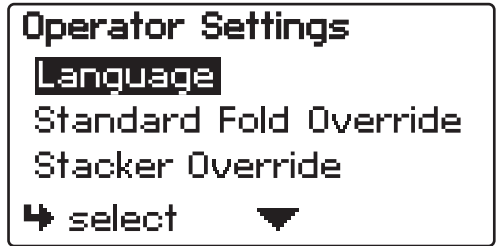

Language

Six languages are available. The factory default is “English US”.



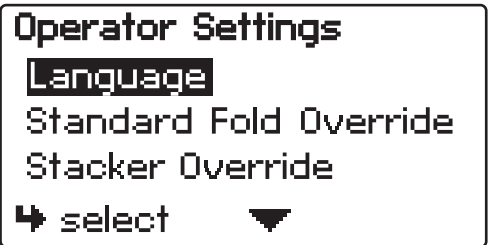











1. To change the language, select “Language” from the Operator Settings screen and press the “↵” button to select.



2. The language choices will be displayed. Press the “▼▲” buttons to highlight your language. Press the “↵” button to enter your selection.



Standard Fold Override

1. It may be necessary to adjust the factory set standard fold settings for a particular fold type and paper size. This can be done in the Standard Fold Override Mode. From the Operator Settings menu select “Standard Fold Override” and press the “” button to select.
2. “Standard folds will be modified from factory settings” will be displayed. Press “” to continue or “C” to exit and return to the main screen.
3. Use the “ ” buttons to select the fold type to be modified. Press the “” button to enter.
4. Use the “ ” buttons to select the paper size. Press the “” button to enter.
5. Adjust Fold Table screen will be displayed. Use the “ ” buttons to change the upper fold table setting. Press the “” button to enter and advance to the lower fold table setting. Adjust the lower fold table and press the “” button to enter and advance to the test screen.
6. Press the “1x” button to ensure the proper folds have been entered. If the folds are correct press the “” button to save and return to the main screen. If the folds need to be adjusted press the “” button to edit.

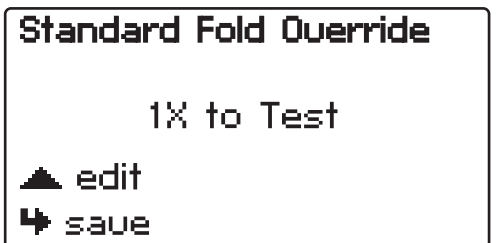
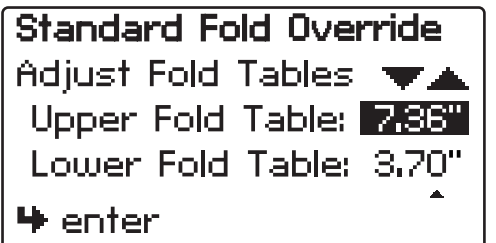
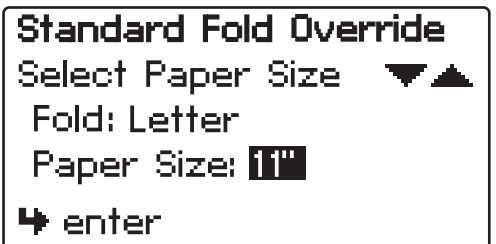
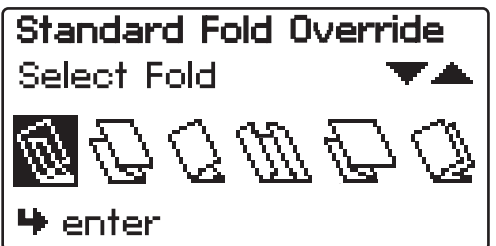
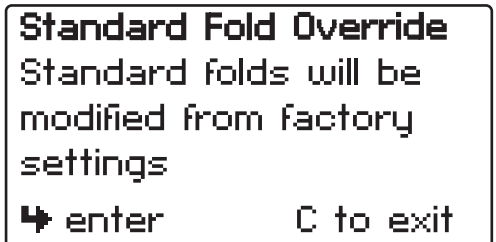
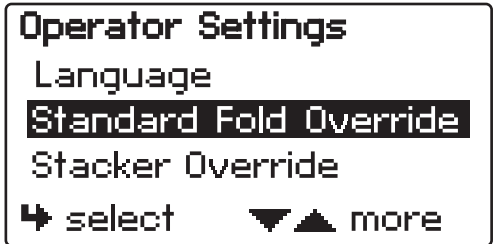



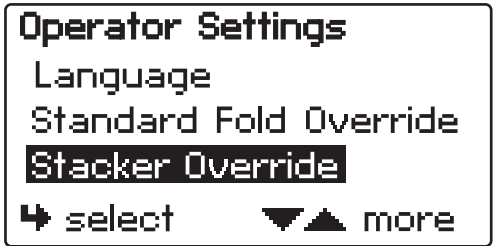

Stacker Override - PF-90 only

The PF-90 automated stacker positions may need to be overridden to accommodate different types of paper in order to improve the outfeed stacking (see pg 19 for PF-80 manual stacker wheel adjustments). The positions are preset at the factory and should only be changed if needed. From the Operator Settings screen select “Stacker Override”, and press the “” to select.

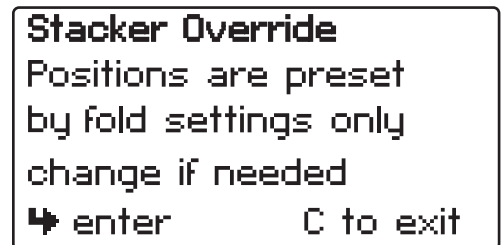



1. “Stacker Override Positions are preset by fold settings only change if needed” will be displayed. Press the “” to enter the stacker override setup or the “C” button to exit.



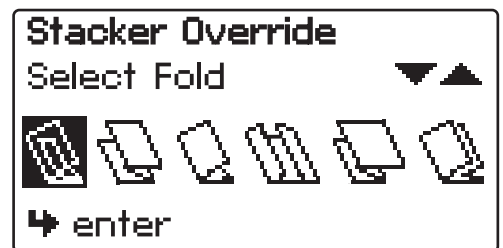

2. Using the “ ” buttons, select the standard fold that the stacker position needs to be adjusted for. Press the “” button to enter the selection.

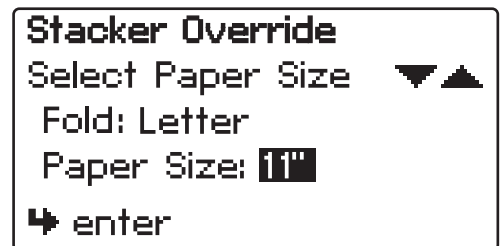

3. Select the paper size using the “ ” buttons. Press the “” button to advance.



4. Adjust the stacker wheel position up or down using the “ ” buttons. The number shown “P1” is the factory setting for the fold type and paper size selected.

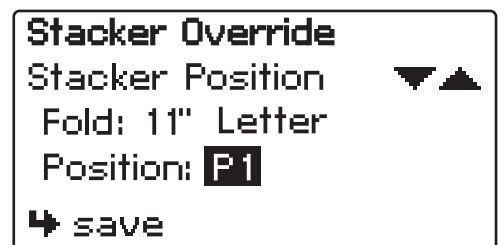

5. Press the “” to save. To adjust stacker settings for additional folds, repeat steps 1 through 4.

Test Sheet Setting

The number of test sheets can be changed between 1, 2 or 3.

1. From the Operator Settings Menu press the “▼” button to highlight Test Sheet Setting. Press the “↵” button to select.
2. Press the “▼▲” buttons to change the test sheet value. Press the “↵” button to save and exit.

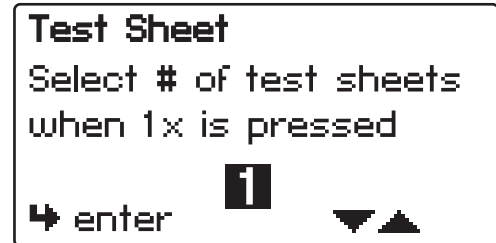

Default Settings

The factory default settings can be reset by accessing the Default Settings mode.

1. From the Operator Settings Menu press the “▼” button to highlight Default Settings. Press the “↵” button to select.
2. Press and hold the “↵” button to reset to the factory default settings. Press the “C” button to exit.

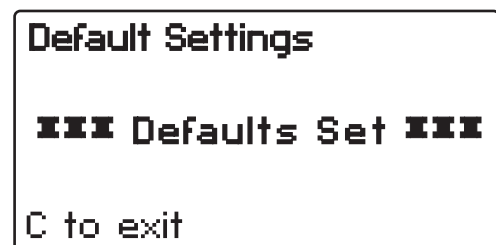
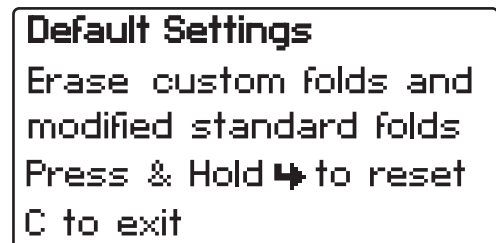

MULTI-SHEET FEEDING

The multi-sheet feeder is designed to fold pre-collated stapled or unstapled sets of up to four 20 # (75gsm) sheets of paper.

1. Adjust the side guides on the multi-sheet feeder for the proper paper size. Loosen the brass thumb screw, adjust the guides to fit the paper width and re-tighten the thumbscrew (Fig 11a).



Fig. 11a

Brass thumbscrew

2. Slide the pre-collated paper set into the multi-sheet feeder. When feeding stapled sets the documents should be placed with the staple on the operator's side and leading (Fig 11b).
3. The sheets of paper will be automatically pulled into the folder (there is a one-second delay after the paper is placed in the feeder).

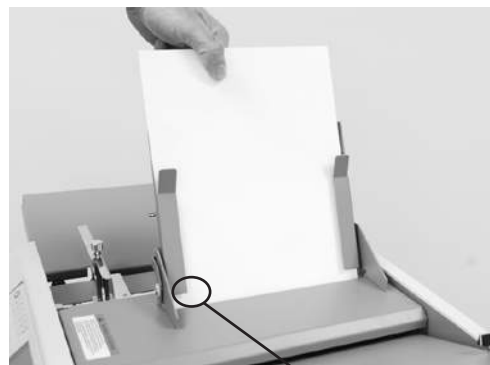

Fig. 12

Staple

4. If the fold is skewed, turn the skew adjustment knob located on the back of the feeder left or right to make corrections (Fig 11c).



Fig 11b

Skew Adjuster

5. To remove the multi-sheet feeder depress the release levers located on either side of the lower back side of the feeder (Fig. 11d), tilt the feeder forward and lift. To reinstall depress the levers and reinsert.

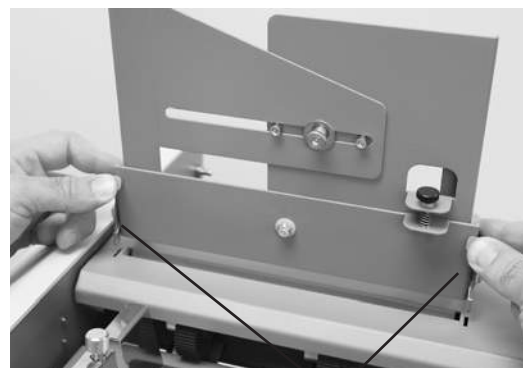

Fig. 11c

Release Levers

CROSS FOLDING

Cross folding refers to folding a document in one pass and then running it through the folder a second time to be folded again.

Common Application: Folding a 11" x 17" document in half and then letter folding it to fit in a standard #10 envelope.

1. Load folded paper into the feed tray with the fold crease facing the non-operator side of the folder (Fig 13a).

Note: For best results, firmly run your hand over the fold crease to help flatten the paper before loading.

2. Attach the cross fold paper guide onto the feed tray paper guide (Fig. 13b) and lower guide.

Note: Cross folding ability will vary based on the paper weight and type. If the paper is too heavy it may not be able to be cross folded.

Note: The guide can be conveniently stored under the lower fold table when not in use (Fig 13c).

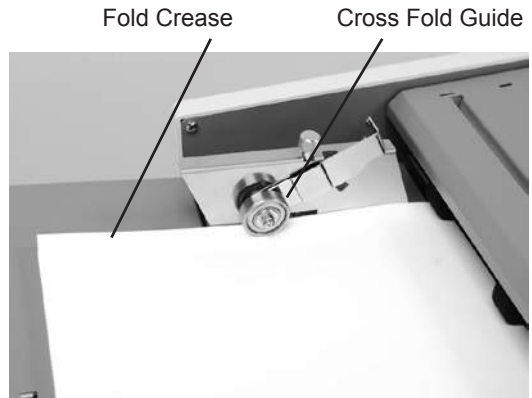

Fig. 13a

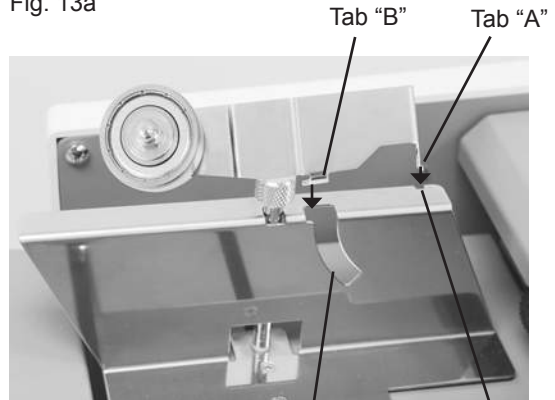

Fig. 13b

To install cross fold guide hook tab "A" into slot "A" and then lower tab "B" into slot "B"



Fig. 13c

Cross fold guide storage

PF-80 STACKER WHEEL POSITIONING GUIDE

Move the stacker wheels to the proper position indicated on the chart based on the fold and paper size Fig 14a and 14b.

	8.5" x 11"	8.5" x 14"	11" x 17"
Letter	A	A or B	B
Zig-Zag	A	A or B	B
Single	B	B	C
Gate	A	B	C
Fold Out	B	C	C
Double II	A	A	A or B

Fig. 14a

Stacker wheels decal



Fig. 14b

Stacker Wheels

THICK PAPER / HIGH SPEED MODE

Thicker paper requires increased speed to fold. In order to fold thicker paper a "Thick Paper / High Speed Mode" can be accessed by pressing and holding the "+" symbol down for 5 seconds. This mode should only be used to fold heavier paper stock.

```
Fold: Letter
Paper Size: 8.5" x 11"
  Thick Paper Mode
Count: 000000
Speed: HS      ↵ Menu
```

REMOVING OUTFEED COVER

The outfeed cover can be removed to access the exit roller. To remove, unscrew thumbscrews that hold the cover in place (Fig. 15)

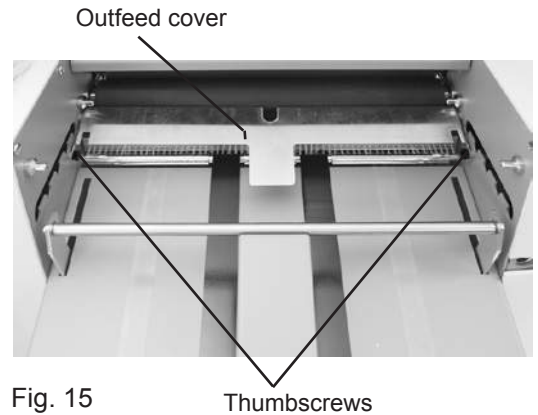

Fig. 15

REMOVING INFEED TIRES

The infeed tires can easily be removed for cleaning and replacement. Remove the Allen screw located on the left side of the feed tire shaft (Fig. 16). Slide the shaft to the right to release from the side frame and remove (Fig. 17).

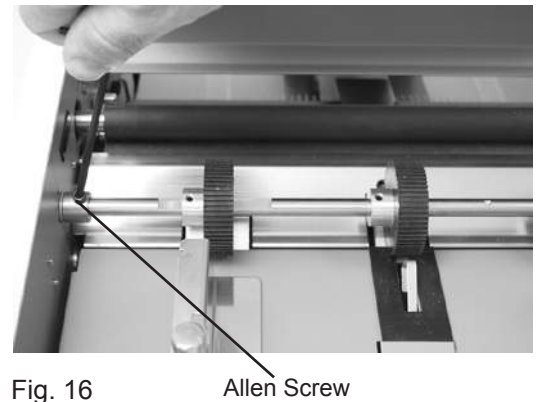

Fig. 16



Fig. 17

OPERATOR MAINTENANCE

1. It is recommended to let forms cool for one-half hour, from the laser printer, before folding. This allows toner to set on the forms and static electricity to discharge. A paper jogger is recommended for best results. The jogger squares the forms and dissipates heat and static electricity created by laser printers.
2. Clean in-feed tires and fold rollers with recommended roller cleaner and cotton cloth to remove paper dust and toner. A damp cloth with water is the best alternative.

CAUTION: Do not use any chemicals other than the recommended roller cleaner or water.

CLEANING PROCEDURES:

1. Make sure machine is turned off and unplugged. All folders have four (4) rubber rollers (Fig. 17).
2. Remove the upper and lower fold tables.
3. Using recommended roller cleaner, spray a new cotton cloth until the cloth is saturated. Wipe the wet cloth in a back and forth motion making sure to clean the entire surface of the fold rollers. Next use a dry cloth and wipe off excess toner. The cloth should be covered with black toner surplus from cleaning the rollers.
4. Run 10-15 sheets of blank copy paper through the folder to ensure all cleaner has been removed from the fold rollers. Running blank sheets will remove any excess residue of cleaner on the rollers.

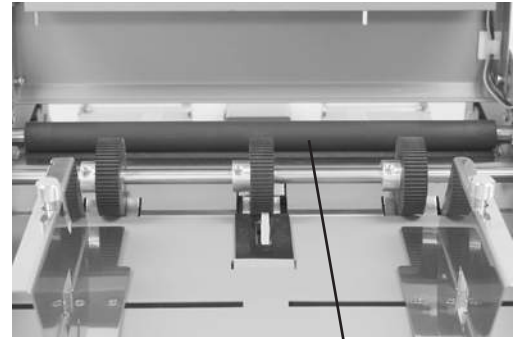

Fig. 18

Fold Rollers

TROUBLE-SHOOTING

TROUBLE	POSSIBLE CAUSE	REMEDY
Control panel lights are not illuminated.	No power at the wall outlet. No power to the machine inlet. No power to the control panel. Internal electrical failure	Check wall outlet. Check power cord for frayed/broken wires. Press the button on the circuit breaker. Call for service.
Fold table stop not moving when "Test"/ "Start" is pressed.	Fold table is not plugged in. Electrical or mechanical failure	Plug in fold table. Call for service.
"Cover Open" is displayed.	Cover open Magnetic switch is broken.	Close cover. Call for service.
"Paper out " is displayed.	In-feed tray is empty.	Place documents on the in-feed tray.
"Paper Jam" is displayed.	Paper misfeed Paper jammed at exit of folder	Reload paper and press "Counter Reset" button. Remove paper and press "Counter Reset" button.
Black marks on the folded paper.	In-feed tires, separator, and/or fold rollers are dirty.	Clean the parts with approved roller cleaner and rejuvenator.
Fold is skewed.	In-feed tray is out of adjustment.	Turn skew adjuster knob to remove the skew.
Stacker belts do not turn.	Broken drive belt, worn drive gear.	Call for service.
Documents are wrinkled or crunched.	Fold tables are not inserted correctly. Piece of paper or other material is stuck in the fold table.	Remove and reinstall fold tables. Be sure they're properly positioned. Remove object from the fold table.
In-feed tray lever does not work	Broken spring	Call for service.
Double feeding forms	Documents stuck together More tension is needed Feed tire or separator worn	Jog forms to remove static electricity. Adjust the infeed tension lever Call for service
Not feeding documents	Feed tire is dirty Feed tire or separator worn	Clean feed tire Call for Service
Power loss	Circuit Breaker tripped Under adverse conditions, power input level may drop below acceptable limits	Press black reset button on back of machine. When power is restored, turn off machine, then turn on again to restore normal operations.

